

# C922 PRO HD STREAM WEBCAM

Complete Setup Guide  
Guide d'installation complet

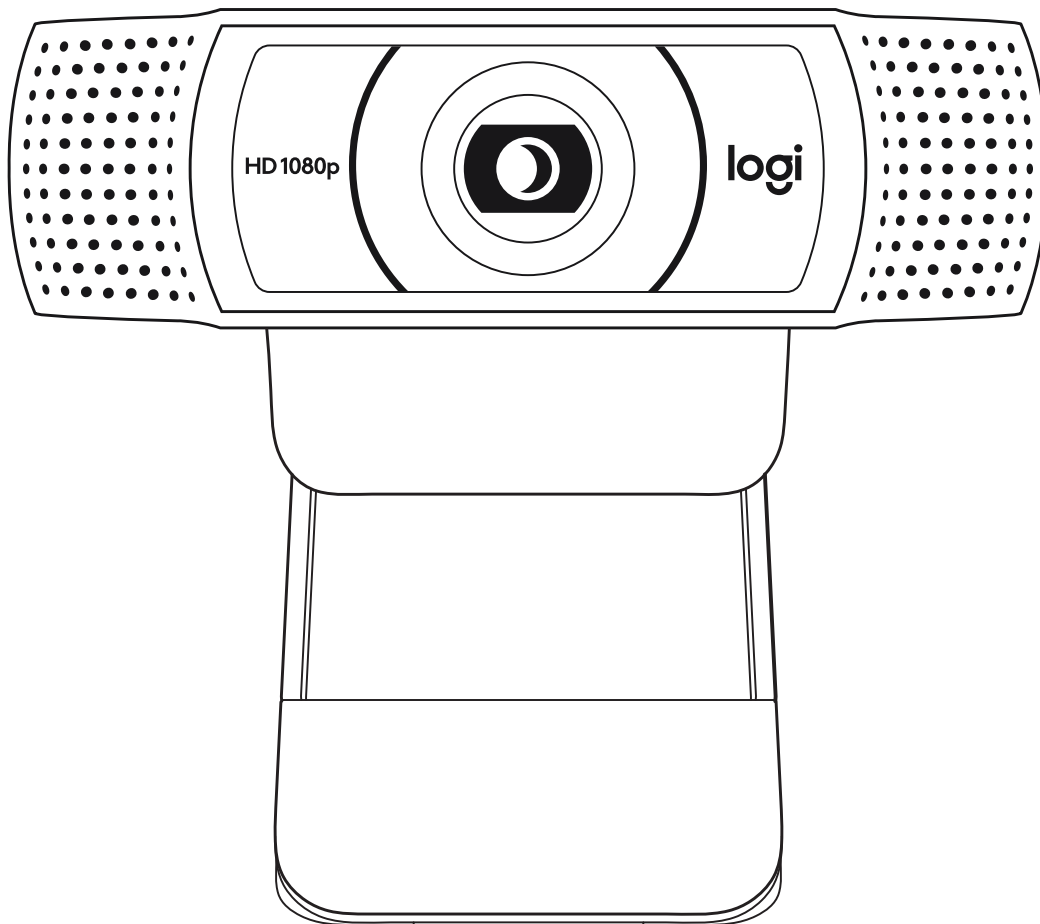

logitech®

## CONTENTS

English . . . . .3

Français . . . . .6

Español . . . . .9

Português . . . . . 12

# KNOW YOUR PRODUCT

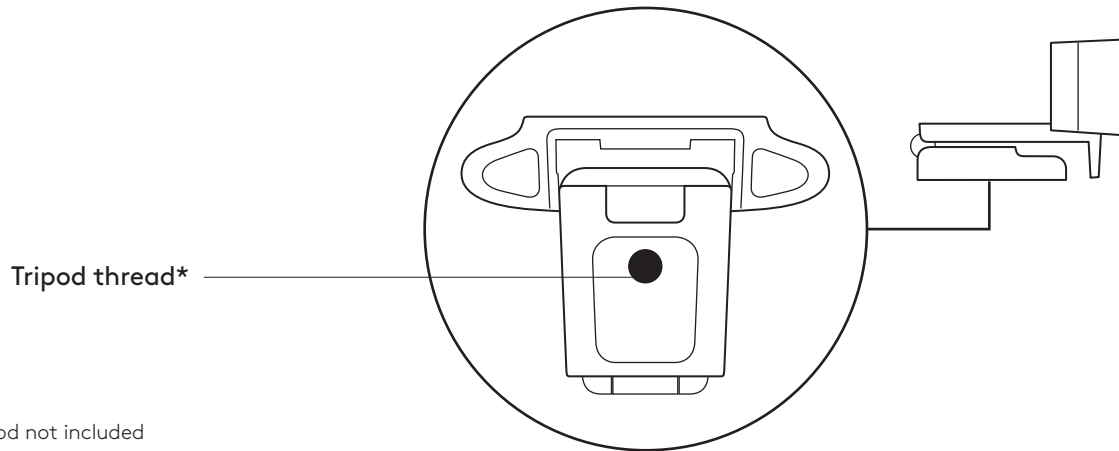
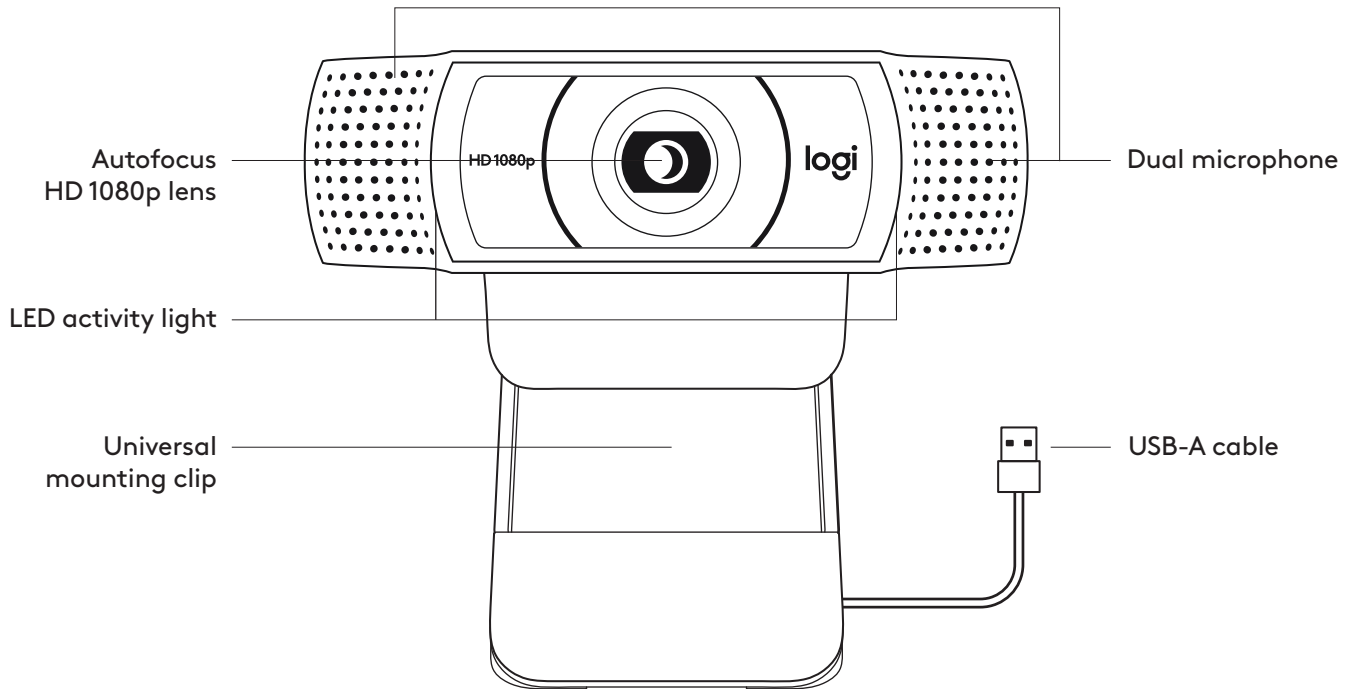

\* Tripod not included

## WHAT'S IN THE BOX

- 1 Webcam with 5 ft (1.5 m) attached USB-A cable
- 2 User documentation

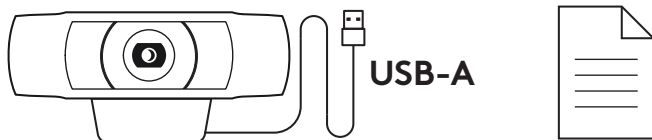

## SETTING UP THE WEBCAM

For placement on a monitor

- 1 Place your webcam on a computer, laptop or monitor at a position or angle you desire.



- 2 Adjust the webcam to make sure the foot on the universal mounting clip is flush with the back of your device.

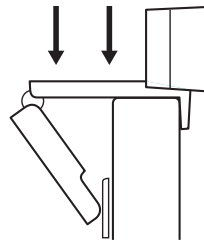

- 3 Manually adjust the webcam up/down to the best position to frame yourself.

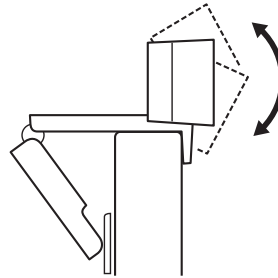

For placement on a tripod\*

- 1 Locate the 1/4 inch tripod thread on the bottom of the universal mounting clip.

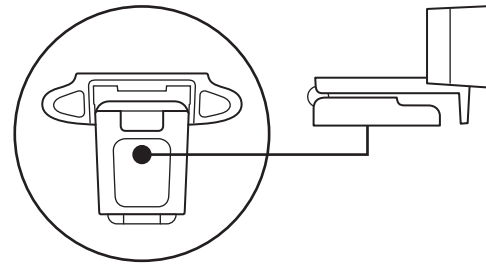

- 2 Secure the webcam on your tripod by twisting it into the 1/4 inch thread.

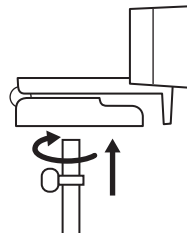

- 3 Place your webcam with the tripod anywhere you desire to the best position to frame yourself.

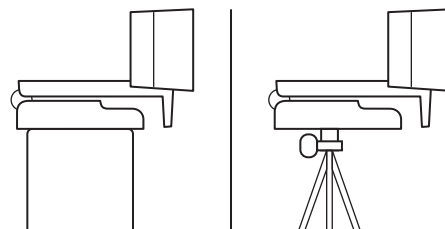

\* Tripod not included

## CONNECTING THE WEBCAM VIA USB-A

Plug the USB-A connector into the USB-A port on your computer.

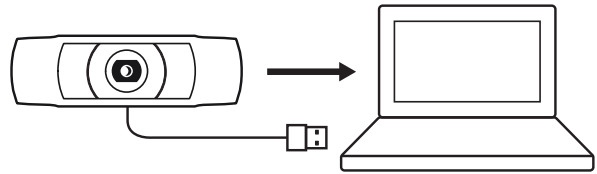

## SUCCESSFUL CONNECTION

LED activity light will light up when the webcam is in use by an application.

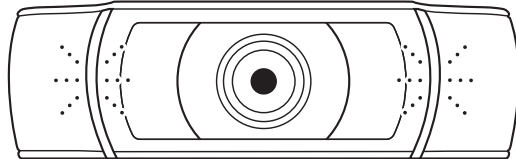

## DIMENSIONS

### INCLUDING FIXED MOUNTING CLIP:

Height x Width x Depth:

1.73 in (44 mm) x 3.74 in (95 mm) x 2.80 in (71 mm)

Cable Length: 5 ft (1.5 m)

Weight: 5.71 oz (162 g)

[www.logitech.com/support/C922](http://www.logitech.com/support/C922)

## PRÉSENTATION DU PRODUIT

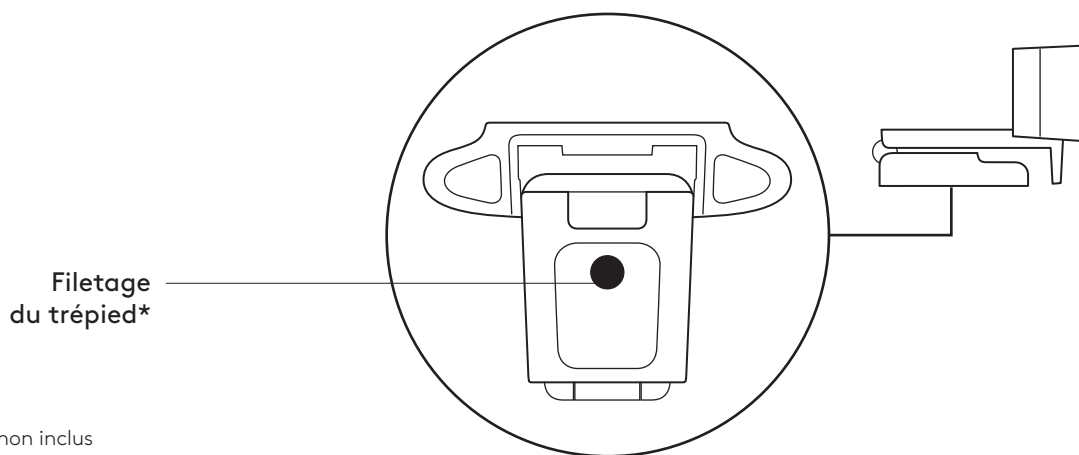
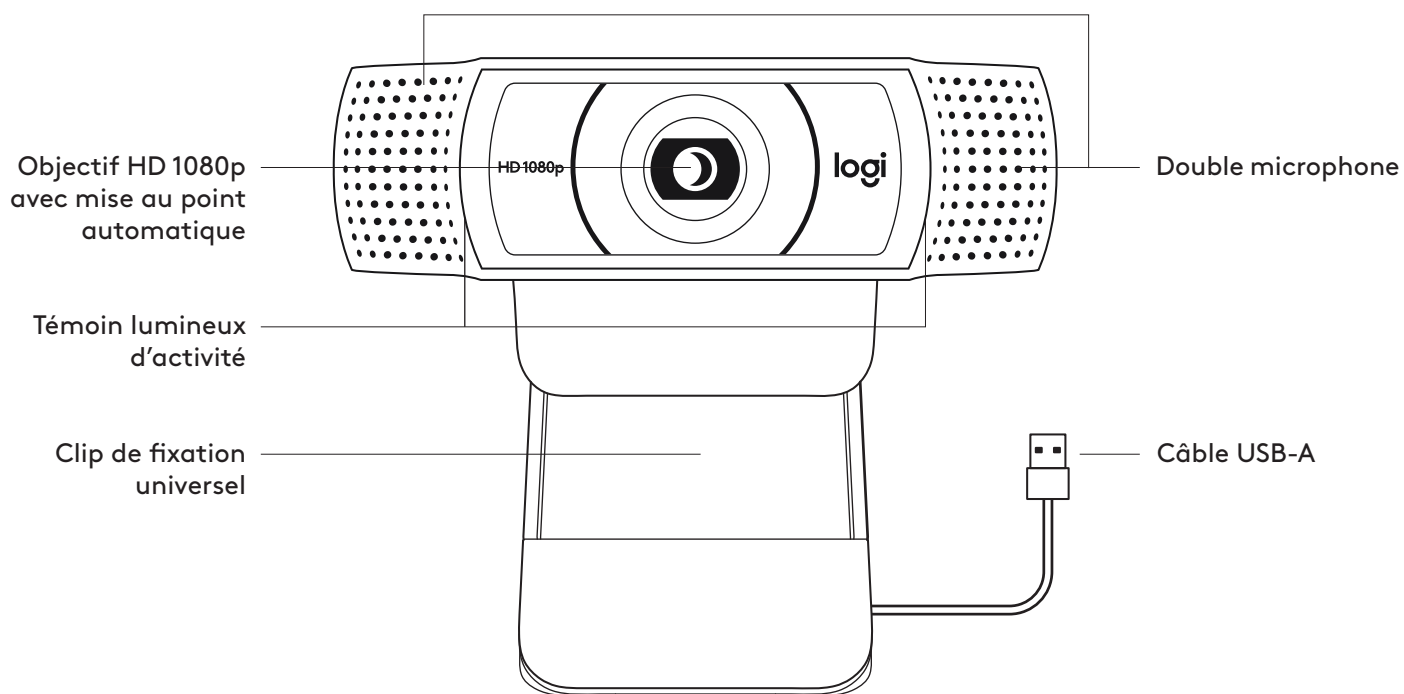

\* Trépied non inclus

### CONTENU

- 1 Webcam avec câble USB-A de 1,5 m (5 pieds) joint
- 2 Documentation utilisateur



## INSTALLATION DE LA WEBCAM

Fixation sur un écran

**1** Placez votre webcam sur un ordinateur, un ordinateur portable ou un écran à l'angle ou dans la position de votre choix.

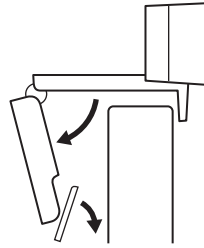

**2** Ajustez la webcam pour vous assurer que le pied du clip de fixation universel est aligné avec l'arrière de votre dispositif.

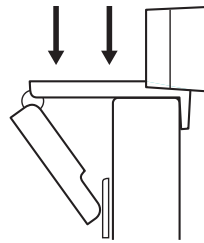

**3** Ajustez manuellement la webcam vers le haut/bas pour vous cadrer au mieux.

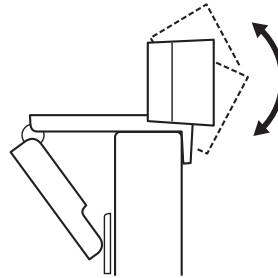

Fixation sur un trépied\*

**1** Recherchez le filetage du trépied de 1/4 pouce sous le clip de montage universel.

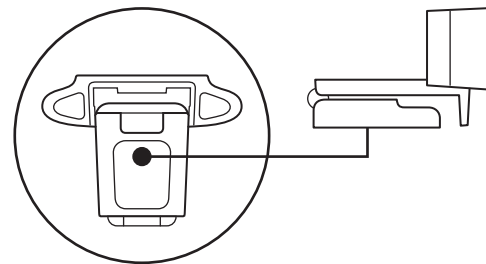

**2** Sécurisez la webcam sur le trépied en la vissant sur le filetage 1/4 pouce.

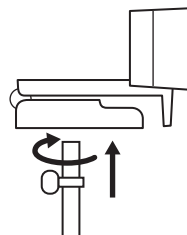

**3** Placez votre webcam sur le trépied selon votre convenance dans la meilleure position pour vous cadrer.

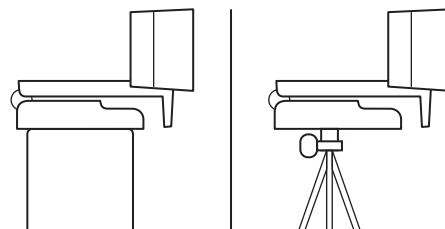

\* Trépied non inclus

## CONNEXION DE LA WEBCAM VIA USB-A

Branchez le connecteur USB-A sur le port USB-A de votre ordinateur.

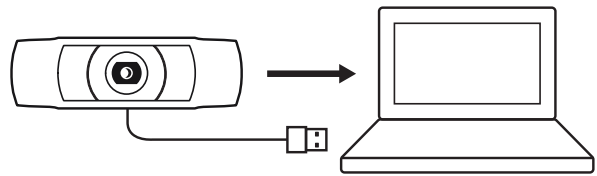

## CONNEXION RÉUSSIE

Le témoin lumineux d'activité s'allumera lorsque la webcam est utilisée par une application.

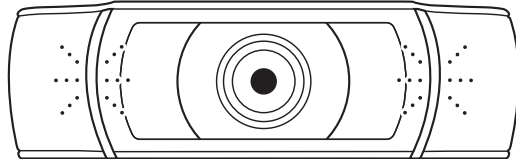

## DIMENSIONS

### AVEC LE CLIP DE FIXATION UNIVERSEL:

Hauteur x largeur x profondeur:

44 mm (1,73 pouce) x 95 mm (3,74 pouces) x 71 mm (2,80 pouces)

Longueur du câble: 1,5 m (5 pieds)

Poids: 162 g (5,71 onces)

[www.logitech.com/support/C922](http://www.logitech.com/support/C922)



## COMPONENTES DEL PRODUCTO

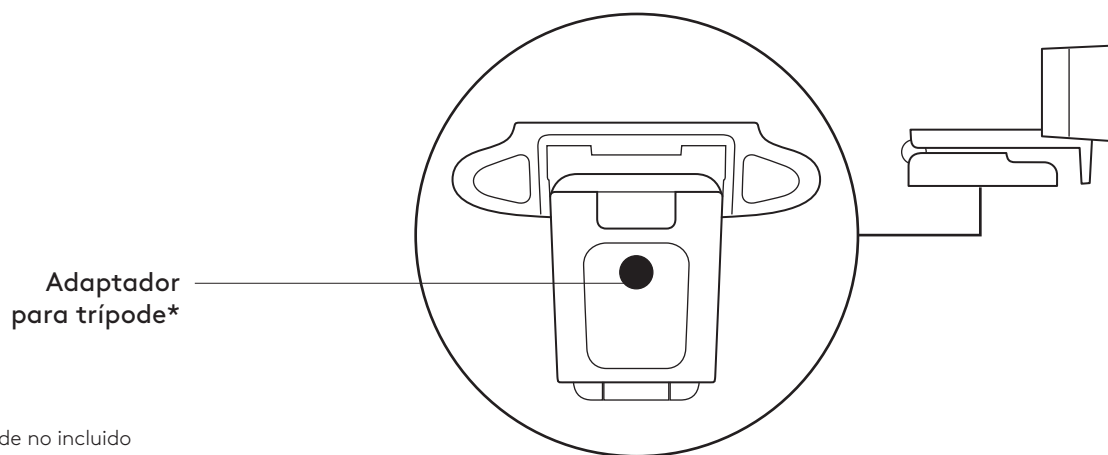
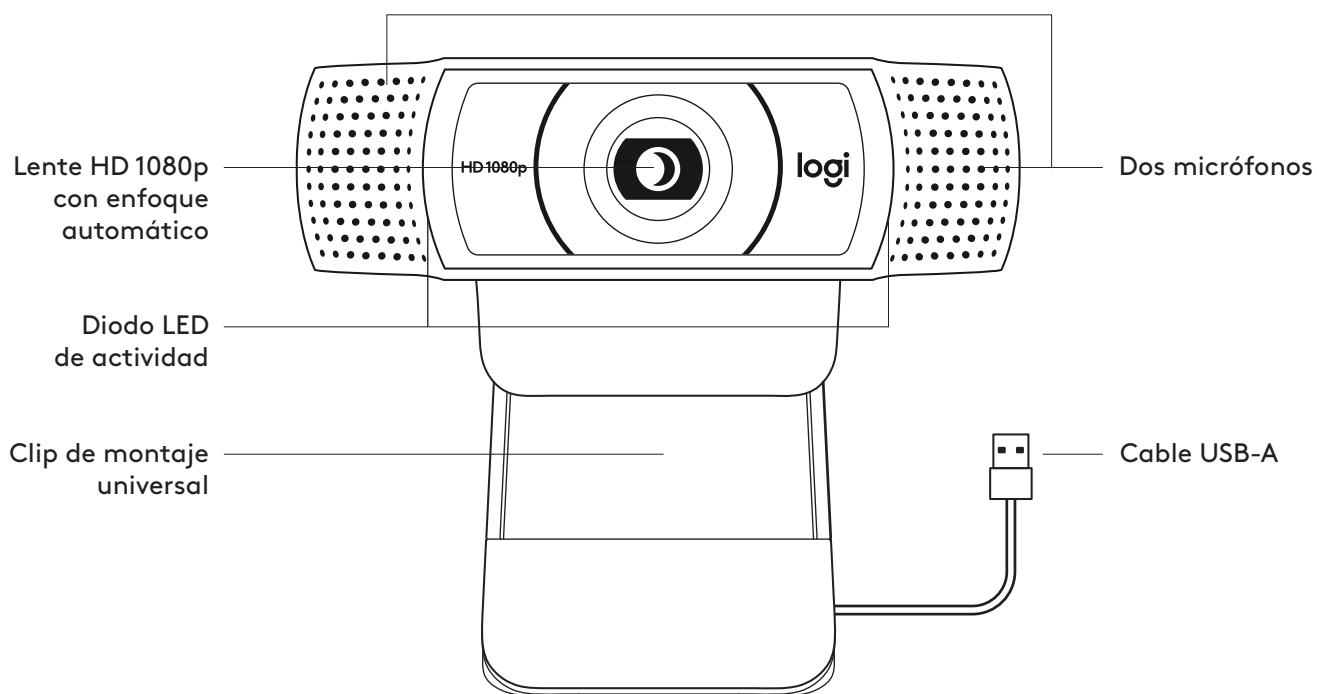

\* Trípode no incluido

### CONTENIDO DE LA CAJA

- 1 Cámara Web con cable USB-A fijo de 1,5 m (5 ft)
- 2 Documentación del usuario

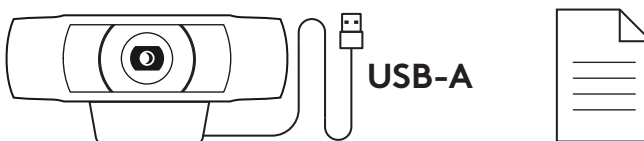

## INSTALACIÓN DE LA CÁMARA WEB

Para la colocación en un monitor

**1** Coloca la cámara sobre una computadora, una laptop o un monitor, en la posición o el ángulo que desees.

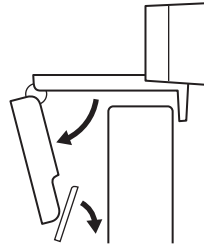

**2** Ajusta la cámara de modo que la pata del clip de montaje universal quede al ras de la parte posterior del dispositivo.

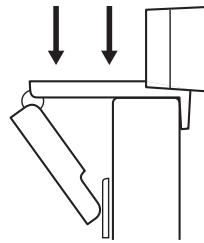

**3** Inclina manualmente la cámara Web hacia arriba/abajo para enmarcarte en la imagen del mejor modo posible.

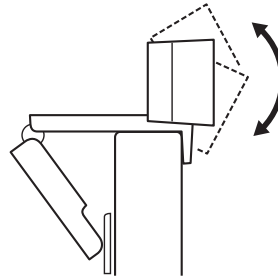

Para la colocación en un monitor\*

**1** Ubica el adaptador para trípode de ¼", en la base del clip de montaje universal.

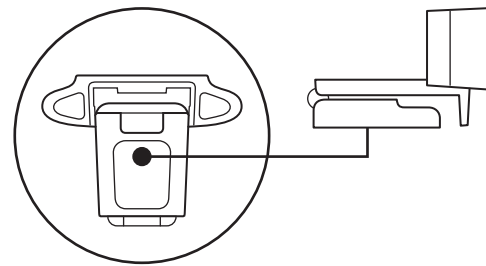

**2** Fija la cámara Web al trípode, girándolo en el adaptador de ¼ de pulgada.

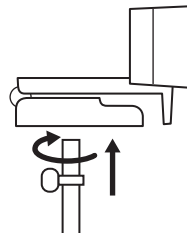

**3** Coloca la cámara Web con el trípode en el sitio que quieras para lograr la mejor posición para enmarcarte perfectamente.

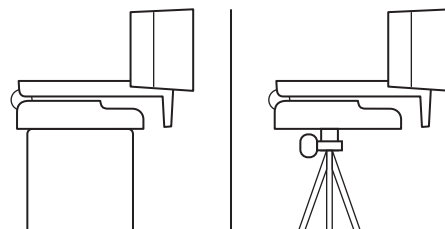

\* Trípode no incluido

## CONEXIÓN DE LA CÁMARA WEB VÍA USB-A

Conecta el cable USB-A al puerto USB-A de la computadora.

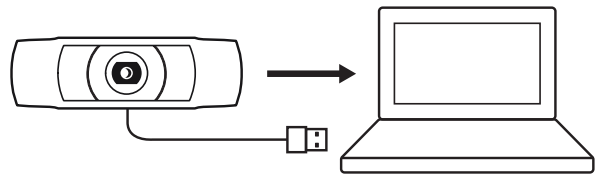

## CONEXIÓN REALIZADA CORRECTAMENTE

El diodo LED de actividad se iluminará cuando la cámara se esté usando en una aplicación.

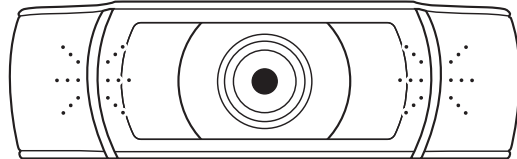

## DIMENSIONES

### CON CLIP DE MONTAJE ACOPLADO:

Altura x Anchura x Profundidad:

44 mm (1,73 in) x 95 mm (3,74 in) x 71 mm (2,80 in)

Longitud del cable: 1,5 m (5 ft)

Peso: 162 g (5,71 oz)

[www.logitech.com/support/C922](http://www.logitech.com/support/C922)

## CONHECER O PRODUTO

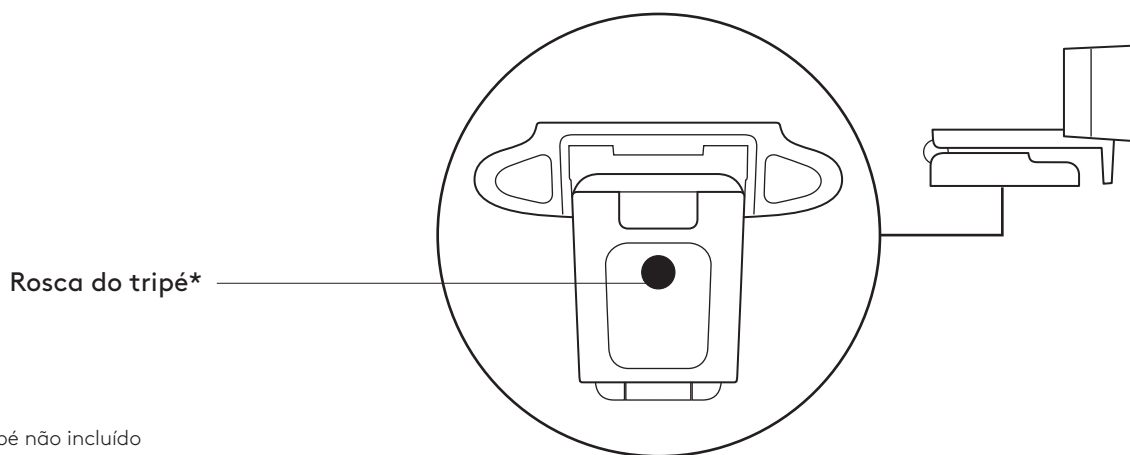
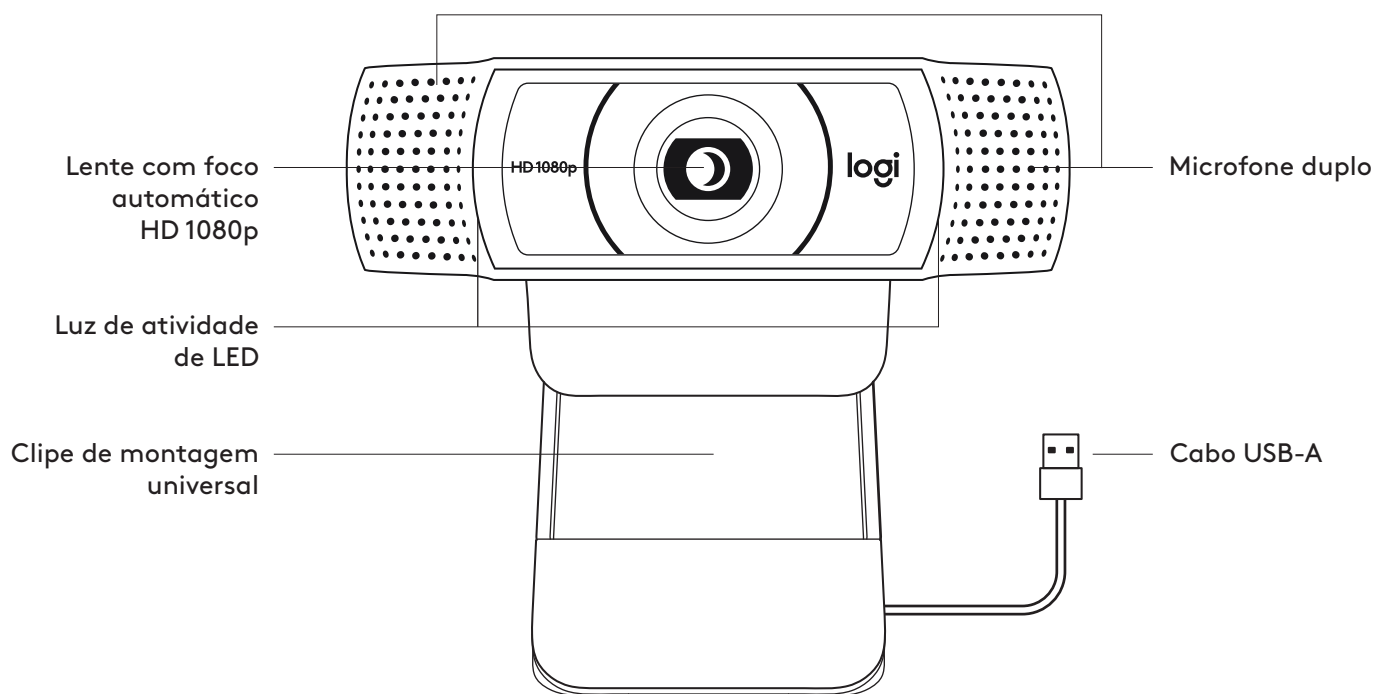

\* Tripé não incluído

### O QUE A CAIXA CONTÉM

- 1 Webcam com cabo USB-A anexo de 1,5 m
- 2 Documentação do usuário

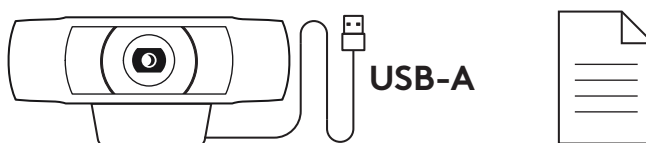

## INSTALAÇÃO DA WEBCAM

Para posicionamento em um monitor

- 1 Posicione a webcam no computador, laptop ou monitor na posição ou ângulo desejado.



- 2 Ajuste a webcam para garantir que o pé do clipe de montagem universal esteja alinhado com a parte de trás do dispositivo.

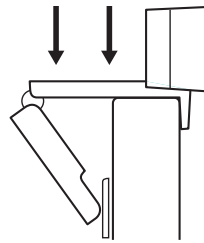

- 3 Ajuste manualmente a webcam para cima/baixo à melhor posição para se enquadrar.

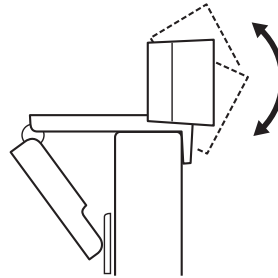

Para posicionamento em um tripé\*

- 1 Localize a rosca do tripé de 1/4 de polegada na parte inferior do clipe de montagem universal.

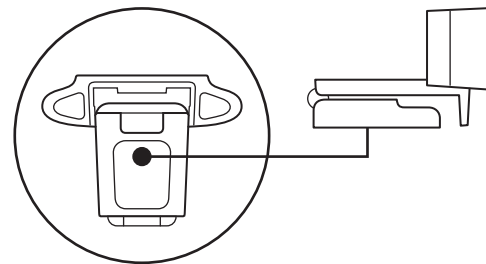

- 2 Prenda a webcam no seu tripé girando o tripé na rosca de 1/4 de polegada.

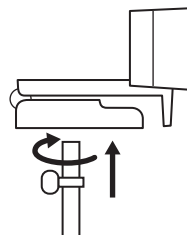

- 3 Coloque sua webcam com o tripé em qualquer lugar que desejar, na melhor posição para se enquadrar.

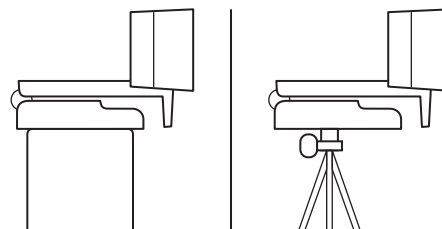

\* Tripé não incluído

## CONECTANDO A WEBCAM VIA USB-A

Conecte o conector USB-A na porta USB-A do seu computador.

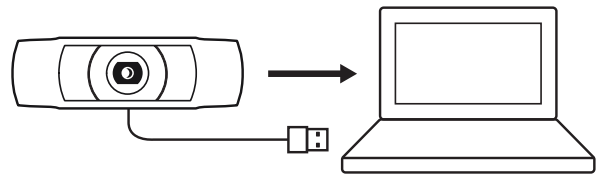

## CONEXÃO BEM-SUCEDIDA

A luz LED de atividade acenderá quando a webcam estiver sendo usada por um aplicativo.

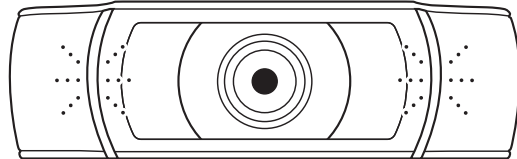

## DIMENSÕES

### INCLUINDO CLIPE DE MONTAGEM FIXO

Altura x largura x profundidade:

44 mm (1,73 pol.) x 95 mm (3,74 pol.) x 71 mm (2,80 pol.)

Comprimento do cabo: 1,5 m

Peso: 162 g (5,71 oz)

[www.logitech.com/support/C922](http://www.logitech.com/support/C922)